

--

Date:
Client:
Project:



5400A3

Thermostatic mixer with 3-way diverter including three separate outlet sockets, 200M.¾" connection to copper, steel, iron or pex pipe work.

Flow

	Bar:	1.0	2.0	3.0	4.0	5.0
Outlet 1	(l/min)	18.5	26.1	32.0	37.0	41.3
Outlet 2	(l/min)	18.5	26.1	32.0	37.0	41.3
Outlet 3	(l/min)	18.5	26.1	32.0	37.0	41.3
Cal Outlet 1	(l/min)	4.4	6.2	7.6	7.6	7.6
Cal Outlet 2	(l/min)	4.4	6.2	7.6	7.6	7.6
Cal Outlet 3	(l/min)	4.4	6.2	7.6	7.6	7.6

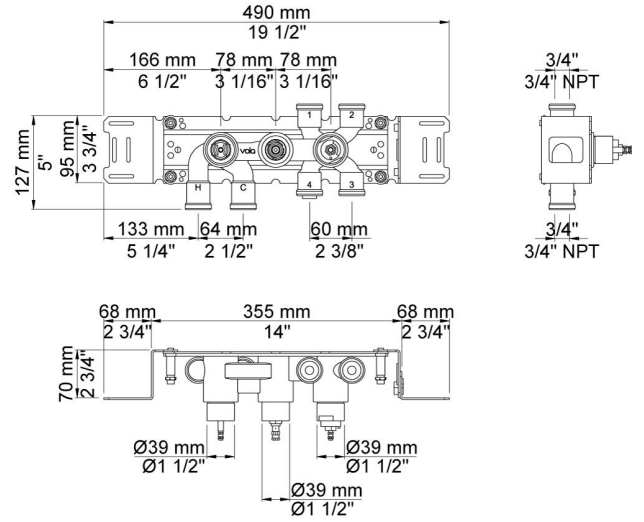

Available in colors



200M

Separate outlet socket.

1/2" connection to copper, steel, iron or pex pipe work.

