

--

Date:
Client:
Project:



CE



**4911VSX**

Build-in basin mixer with on-off sensor for 'hands free' operation. For vertical mounting. Sensor aligned with wall. Valve box VR2618 included. 4911VSXUP = Mixer 4900VSX, sensor cable VR509. 4911VSXAP = Handle NR41, sensor VR510, 160 mm spout 010, 60 mm circular flanges 001, 3001, VR512.

Ada approved.

**Flow**

	Bar:	1.0	2.0	3.0	4.0	5.0
4911VSX	(l/min)	2.9	4.1	5.0	5.0	5.0
4911VSX <sup>1)</sup>	(l/min)	2.6	3.7	4.5	4.5	4.5

<sup>1)</sup> USA Standard

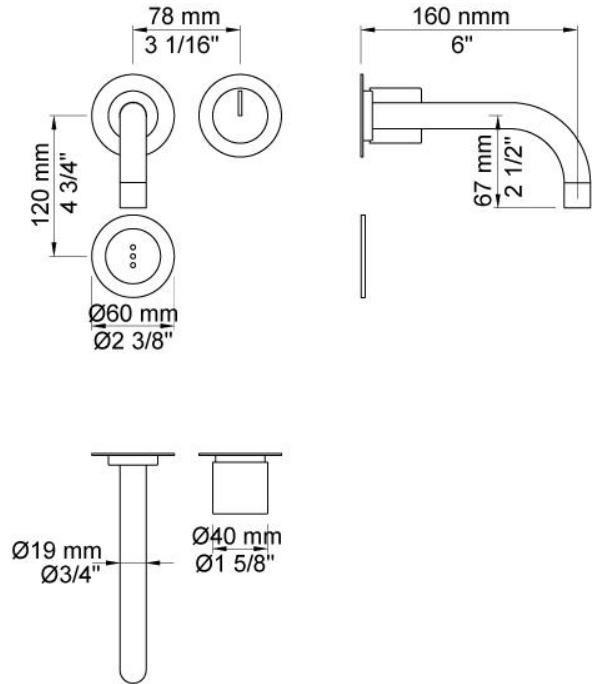

**Available in colors**

	Color 20, Brushed chrome
Color 02, Grey	Color 21, Carmine red
Color 04, Light blue	Color 25, Pink
Color 05, Orange	Color 27, Matt black
Color 06, Light green	Color 28, Matt white
Color 08, Yellow	Color 40, Brushed stainless steel
Color 09, Dark grey	Color 60, Black
Color 12, Mocca	Color 61, Brushed black
Color 14, Bright red	Color 63, Copper
Color 15, Dark blue	Color 64, Brushed Copper
Color 16, Polished chrome	Color 65, Gold
Color 17, Gloss black	Color 68, Silver
Color 18, White	Color 70, Brushed Gold
Color 19, Natural brass	



**001**  
60 mm circular flange. Hole Ø30 mm.

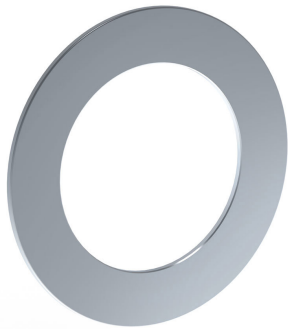

**3001**  
60 mm circular flange. Hole Ø36 mm.

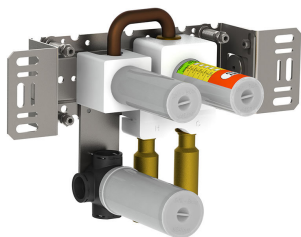
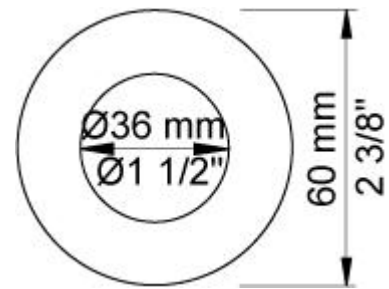

**4900VSX**  
Build-in basin mixer with on-off sensor for 'hands free' operation, with temperature regulation, mixer to the right. Valve box for electronic mixer, VR2618 included.

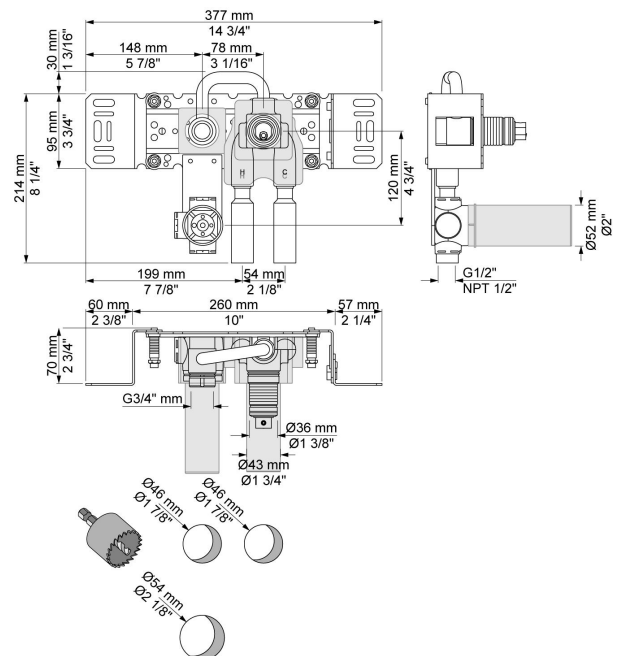



**NR41**  
Temperature control handle for wall-mounted electronic mixer 4900.

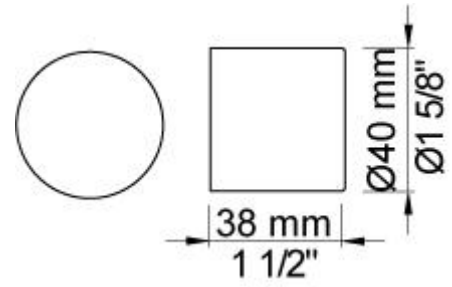

**VR2618**  
Valve box.

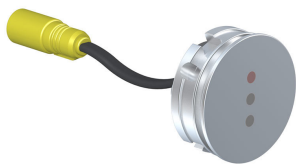
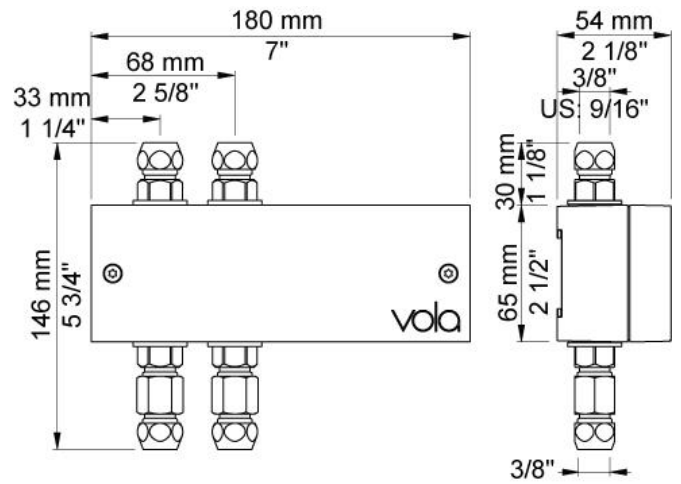

**VR510**  
Sensor for electronic tap 4300, 4800 and 4900.

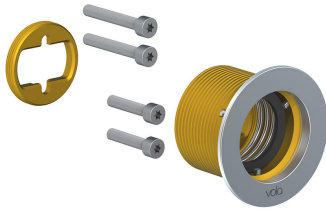

**VR512**

60 mm circular flange. Hole  $\varnothing 38$  mm for 4300, 4800 and 4900.

